

**75**

08/08/2012  
VC87

## **NESTING DIAGRAMS**

The information in the table to Clause 74 is set out in the following diagrams as a means of indicating the nesting of land use terms.

Land use terms that are not nested are listed separately. If there is any inconsistency between the table and the diagrams or list, the table to Clause 74 prevails.

**75.01 ACCOMMODATION GROUP**

15/12/2008  
VC50

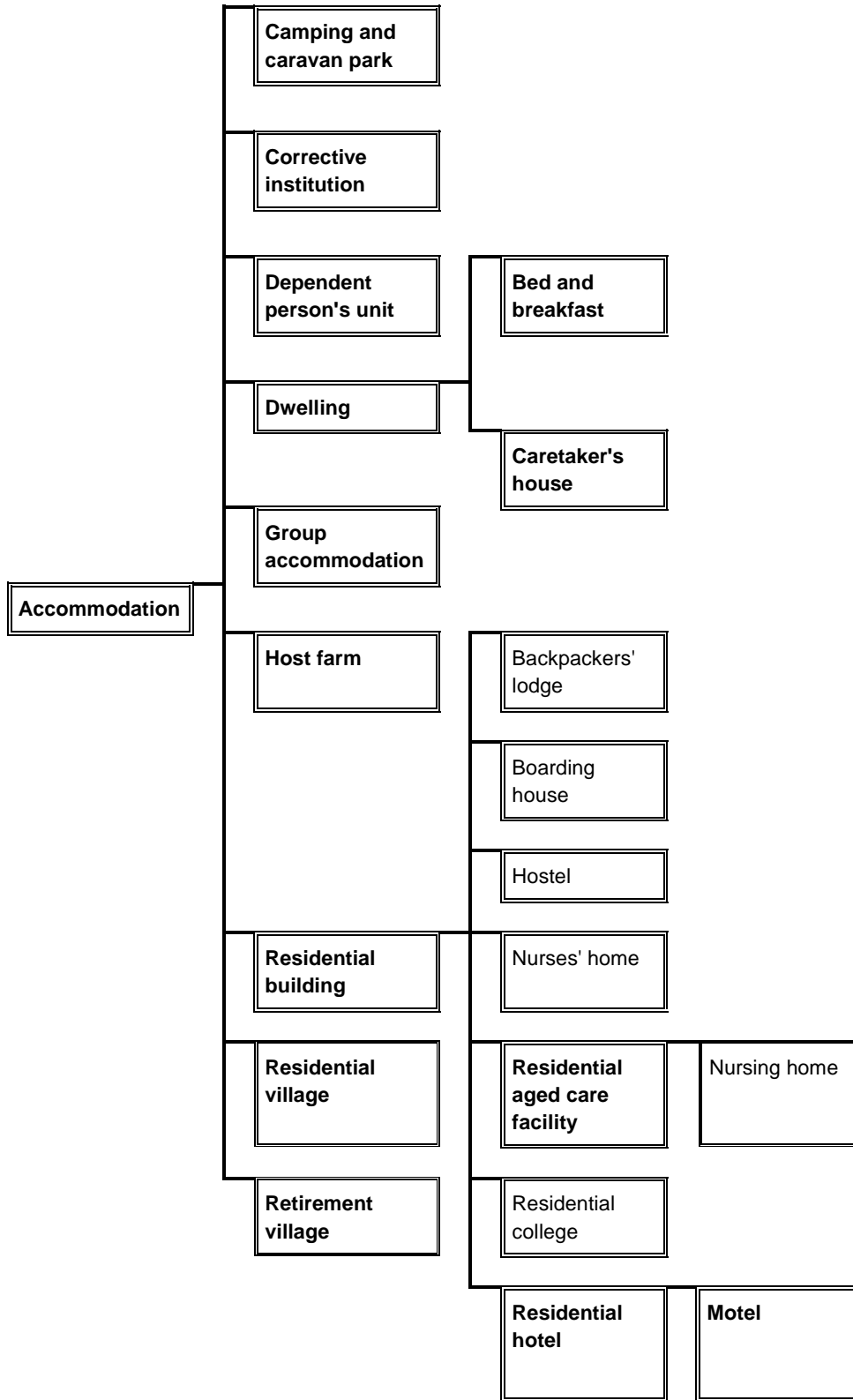

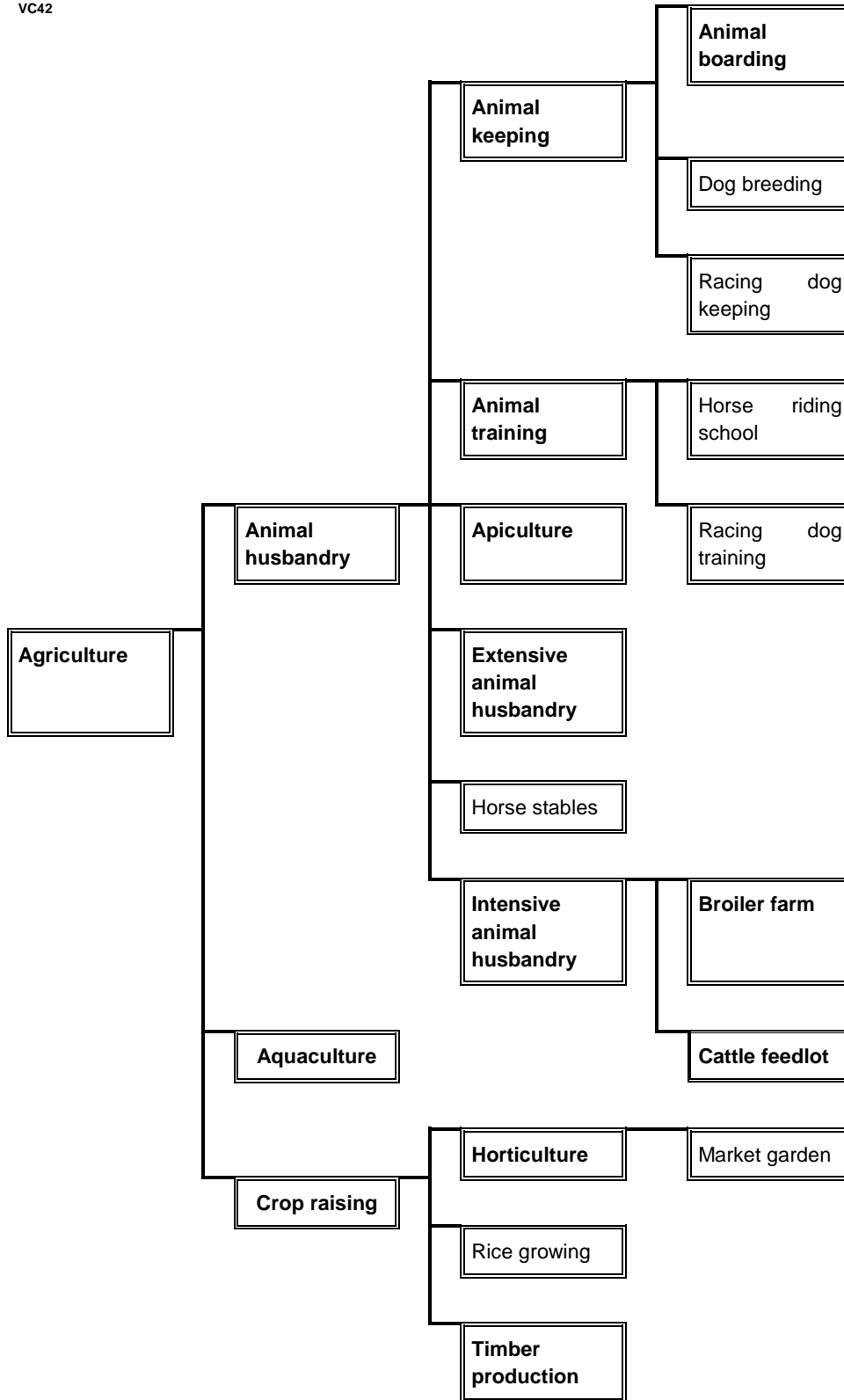

**75.03 CHILD CARE CENTRE GROUP**

09/10/2006  
VC42

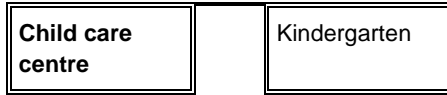

**75.04 EDUCATION CENTRE GROUP**

09/10/2006  
VC42

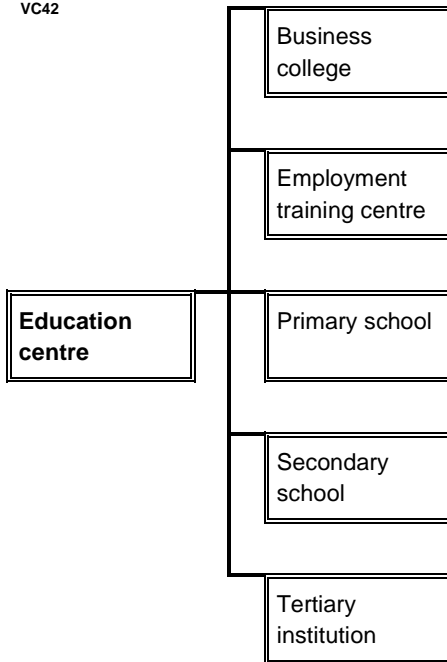

**75.05**

08/08/2012  
VC87

**INDUSTRY GROUP**

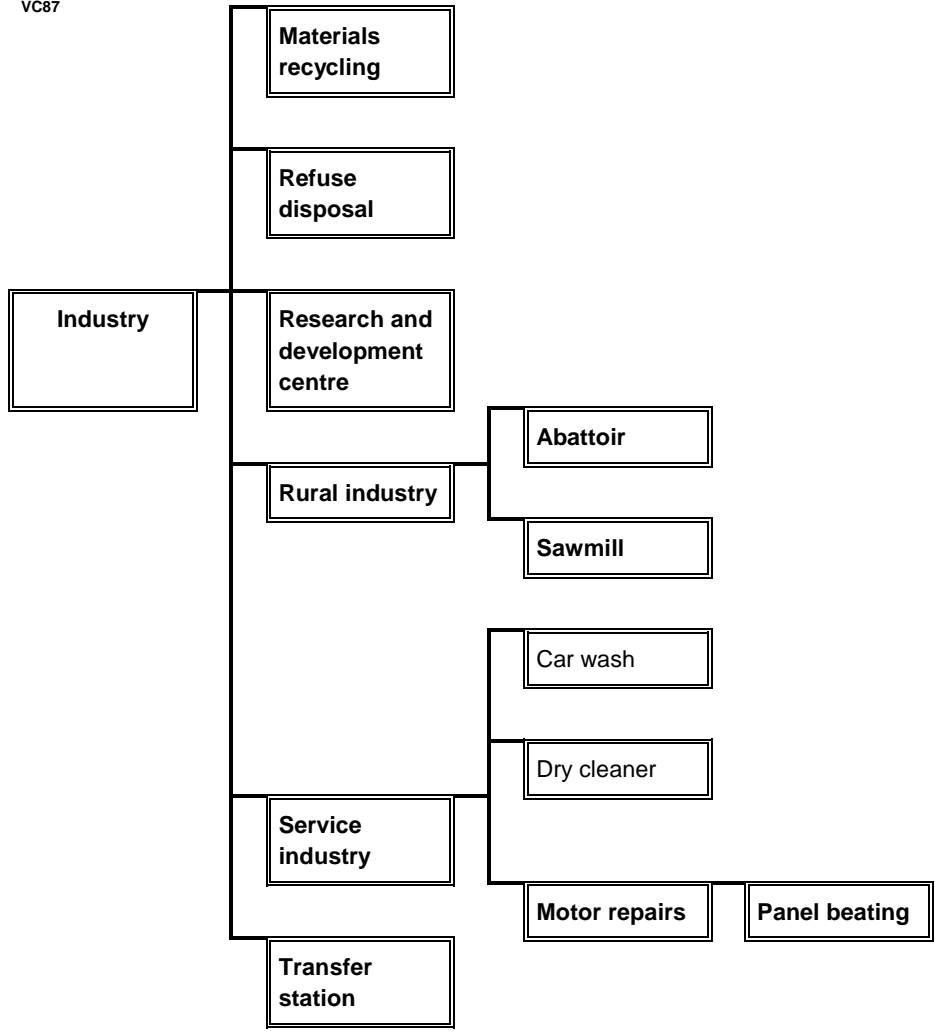

**75.06**

09/10/2006  
VC42

**LEISURE AND RECREATION GROUP**

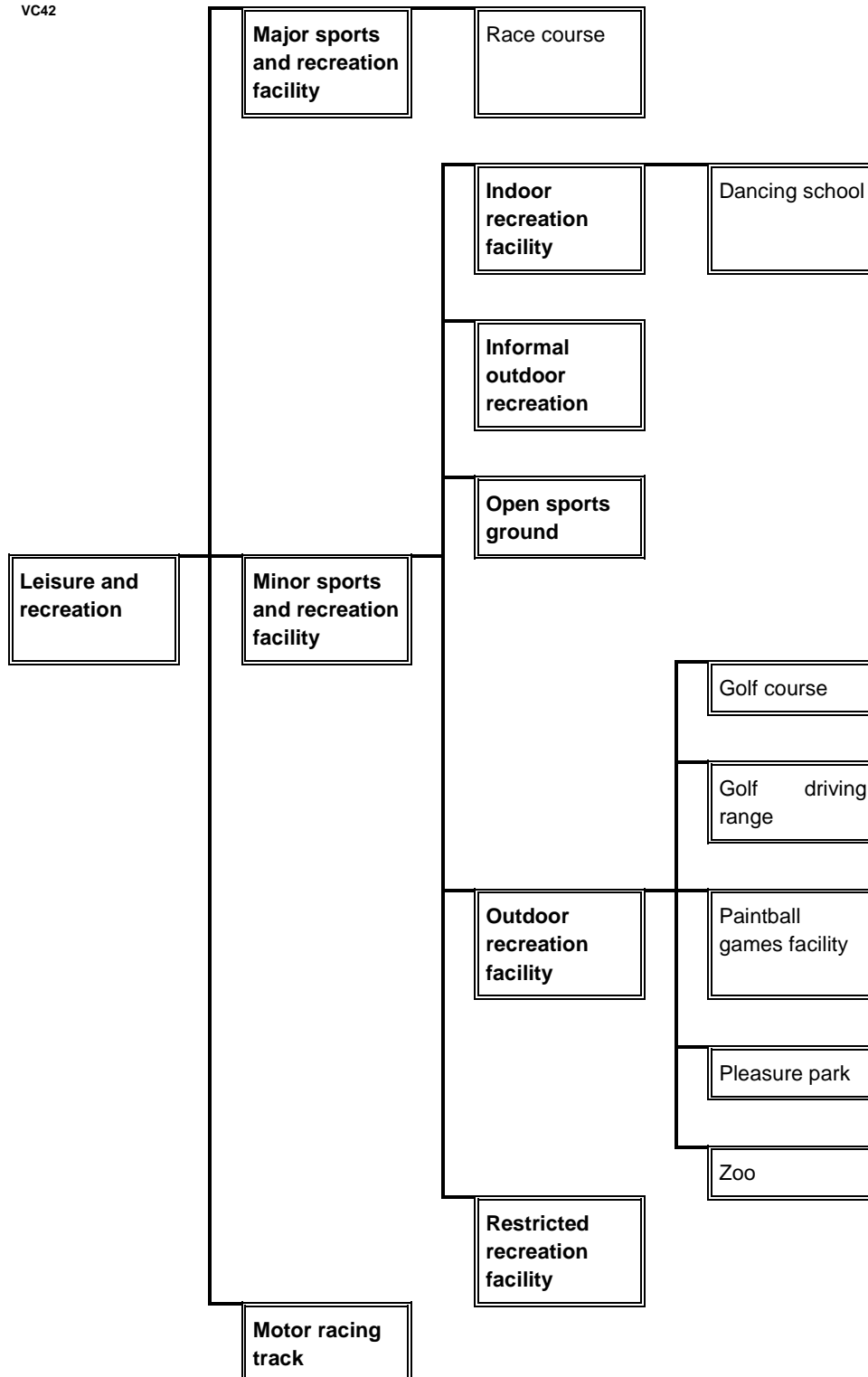

75.07

**EARTH AND ENERGY RESOURCES GROUP**

23/09/2011  
VC77

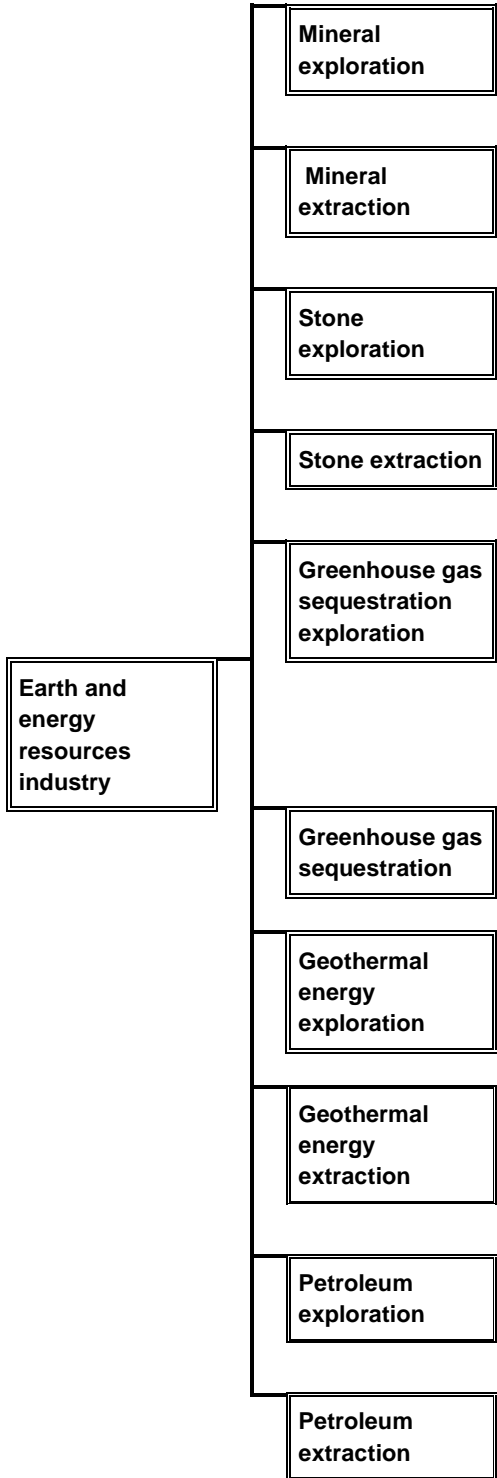

**75.08**

09/10/2006  
VC42

**OFFICE GROUP**

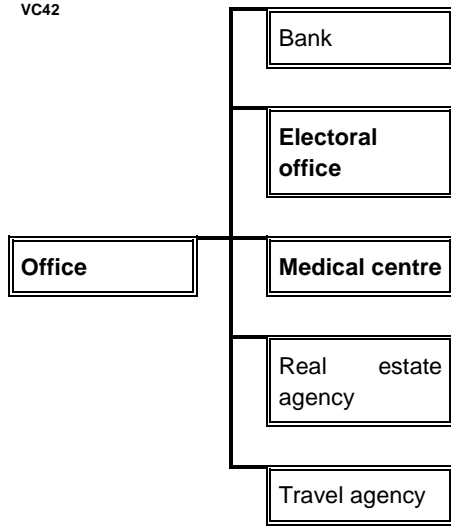



**75.09**

09/10/2006  
VC42

**PLACE OF ASSEMBLY GROUP**

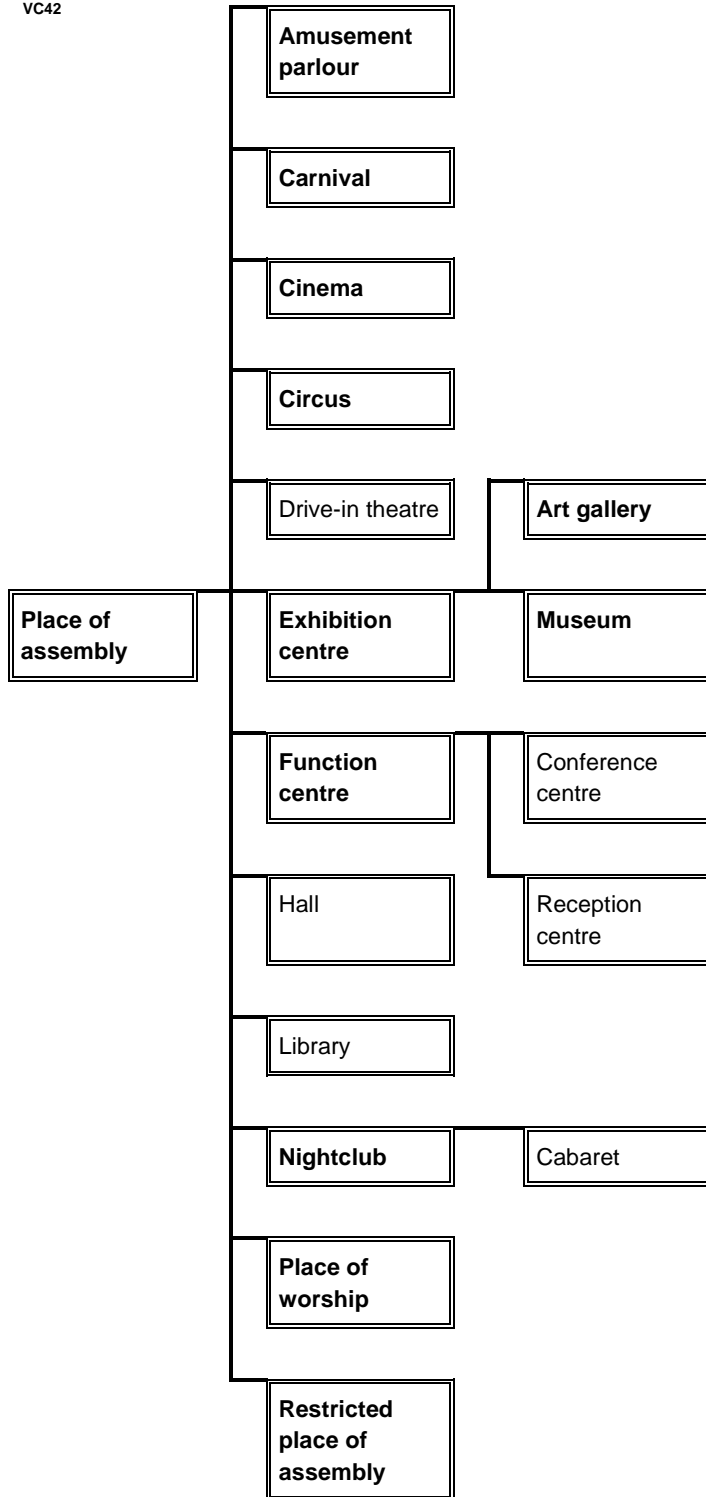

**75.10**

09/10/2006  
VC42

**PLEASURE BOAT FACILITY GROUP**

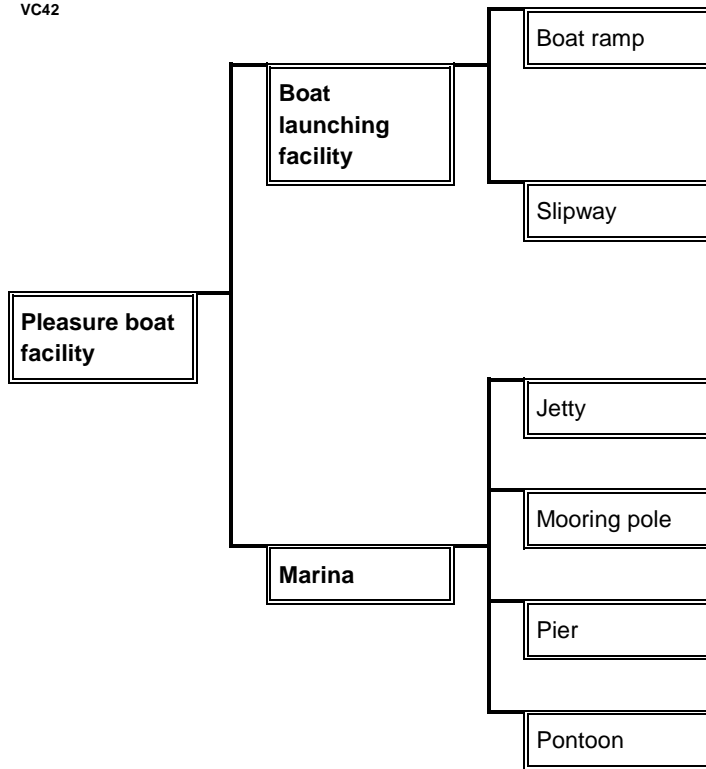

75.11  
09/10/2006  
VC42

## RETAIL PREMISES GROUP

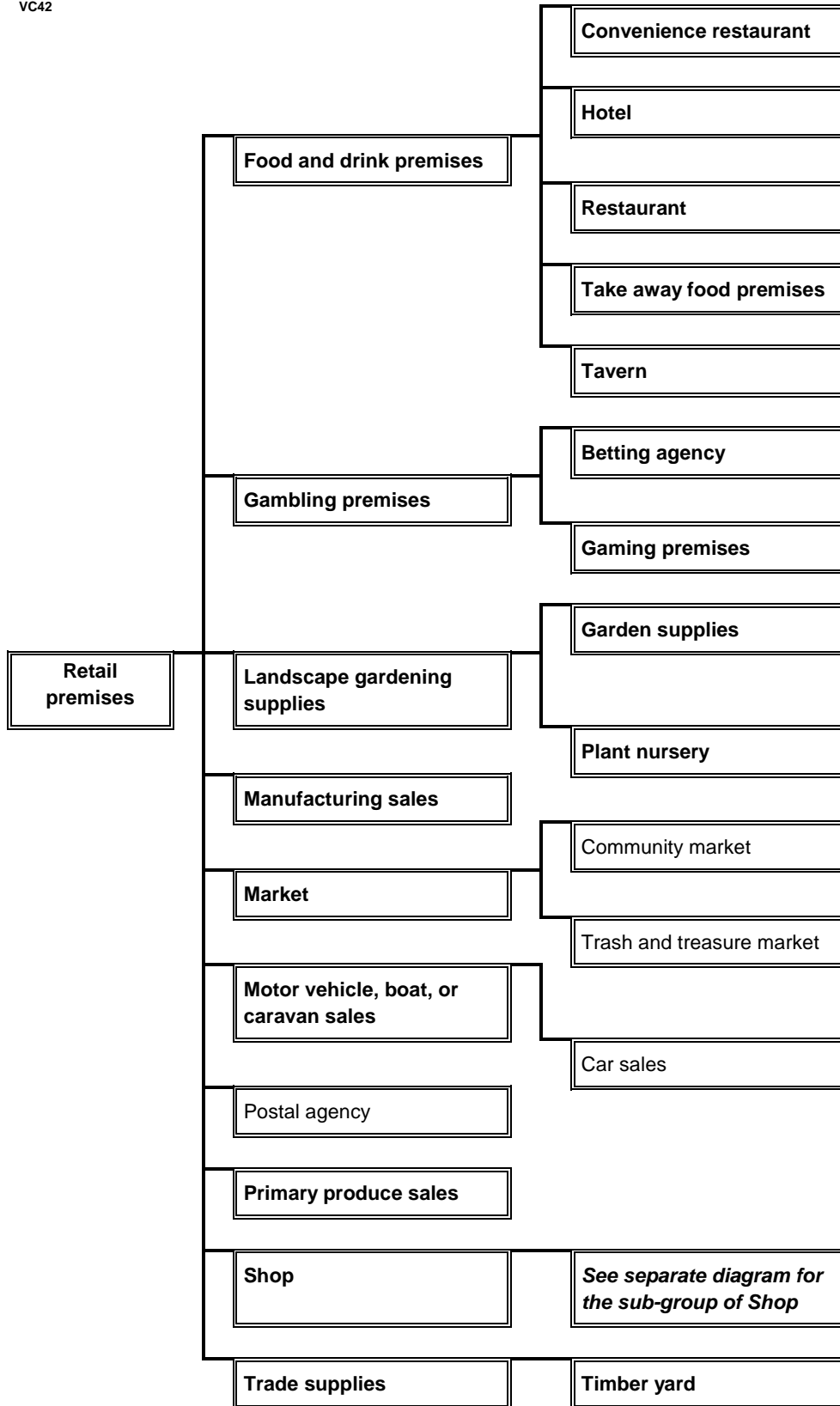

75.12

RETAIL PREMISES GROUP (SUB-GROUP OF SHOP)

08/08/2012  
VC87

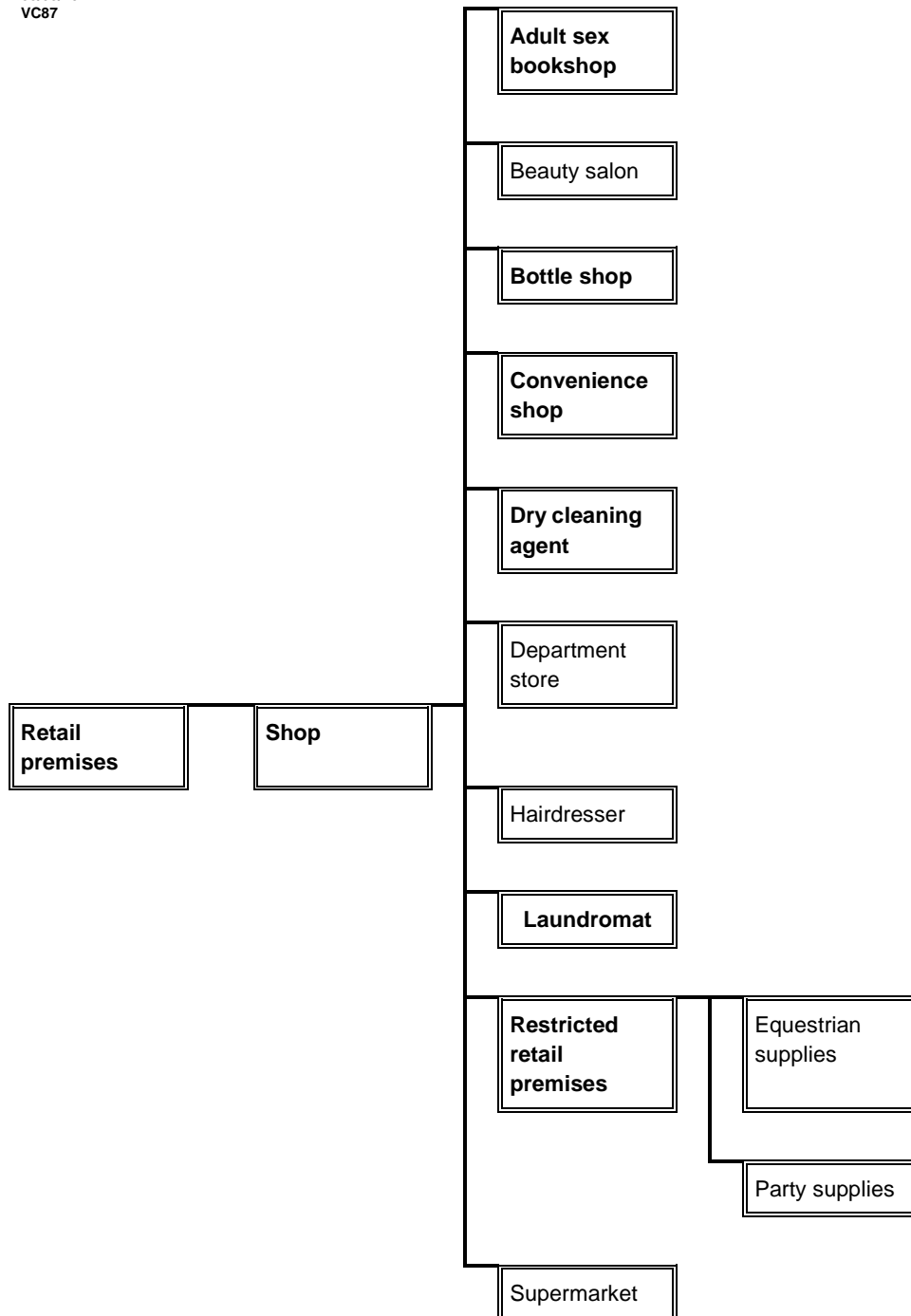

**75.13 TRANSPORT TERMINAL GROUP**

09/10/2006  
VC42

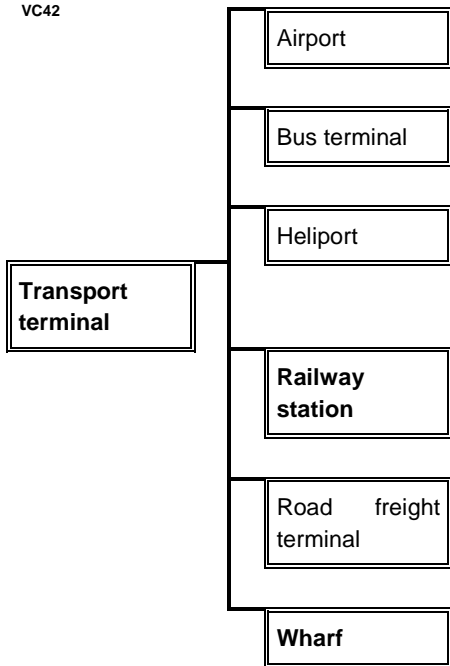

**75.14 UTILITY INSTALLATION GROUP**

09/10/2006  
VC42

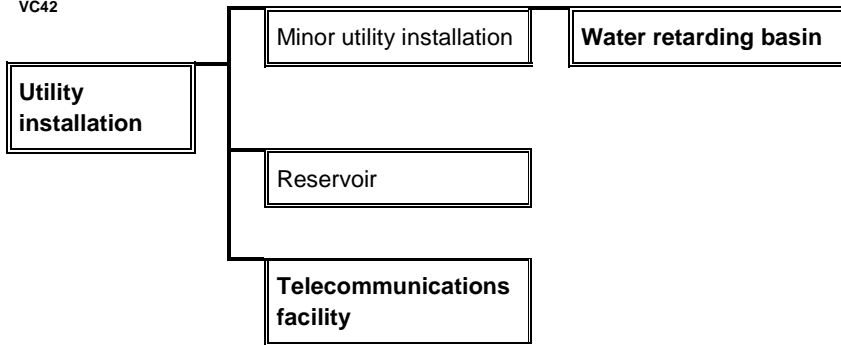

**75.15**

09/10/2006  
VC42

**WAREHOUSE GROUP**

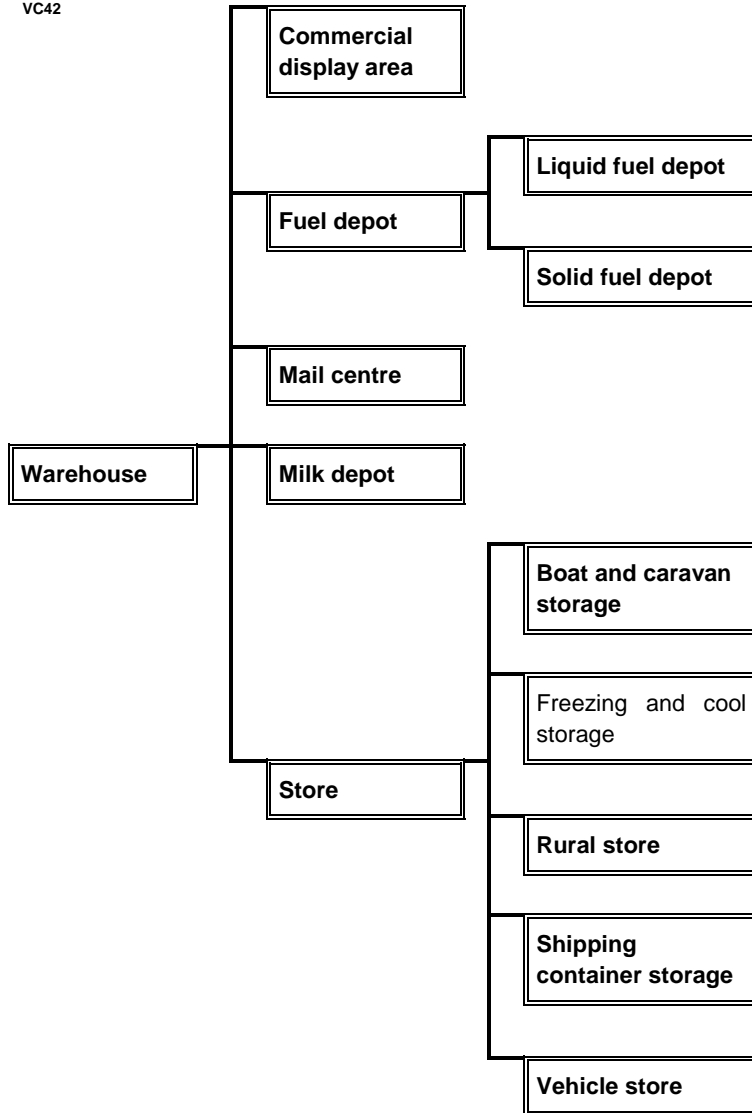

**75.16**

21/09/2009  
VC60

**RENEWABLE ENERGY GROUP**

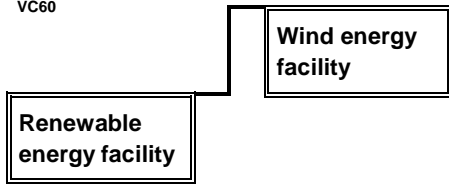

**75.17**

23/09/2011  
VC77

**LAND USE TERMS THAT ARE NOT NESTED**

**Art and craft centre**

**Brothel**

**Car park**

**Cemetery**

**Cinema based entertainment facility**

**Crematorium**

**Display home**

**Emergency services facility**

**Freeway service centre**

**Funeral parlour**

**Home occupation**

**Hospital**

**Natural systems**

**Research centre**

**Saleyard**

**Service station**

**Tramway**

**Veterinary centre**

**Winery**